

P.7

Reactors for filtering



Reactors for filtering

Introduction	3
P.7 - Reactors for filtering	
Product selection table	5
Reactors R / RB	
Reactors III for harmonic rejection filters (for FR)	7
Reactors RE / RBE	
Reactors III for harmonic rejection filters (for FRE static)	10
Reactors LR / LRB	
Reactors for filtering for power converters (network side)	12

Reactors for filtering

Many of the low voltage alteration problems can be corrected with filters. In particular, **CIRCUTOR** has developed an integral power filter manufacturing program to correct the following problems:

- Resonance problems in the LV networks, caused by the power factor compensation equipment
- Rejection of harmonics in some parts of the installation
- Absorption of harmonics to reduce the distortion rate (THD) of the installation
- Limitation of the short-circuit power in some installation points
- Filtering of the current absorbed by static converters (speed variators, etc.) in the alternating or direct current side.

CIRCUTOR has the adequate machinery to manufacture any type of LV reactors, in accordance with the customer's specifications.

Reactors for rejection filters

A series of capacitor capacitor banks with rejection reactors must be installed to compensate the reactive energy in installations with a high content of harmonics.

In this case, the solution entails the addition of a reactor in series with each capacitor, forming a rejection filter with

a resonance frequency that is far away from the harmonic frequencies present in the network.

The purpose of the rejection filter is to prevent the resonance between the inductive impedance resulting from the line, power supply transformer and capacitors installed to compensate the power factor and thus prevent an overload of harmonics in the line and the capacitors.

The filter is composed of various *L-C* branches, with a special configuration and response curve, as shown in Fig. 1. The complete filter set can be composed with any number of branches to compensate the reactive energy present in the installation.

The reactors for this type of filters are specified by the so-called "overvoltage factor", *p*%, which provides the ration between the reactor and capacitor voltages, establishing the resonance of the *L-C* set. In addition, it tunes a different frequency that is far from harmonic frequencies.

$$p (\%) = 100 \cdot U_L / U_C = 100 \cdot (f / f_r)^2$$

U_L : Voltage drop in the reactor

U_C : Resulting voltage in the capacitor

f: nominal frequency in the network

f_r : serial frequency tuned by the *L-C* set

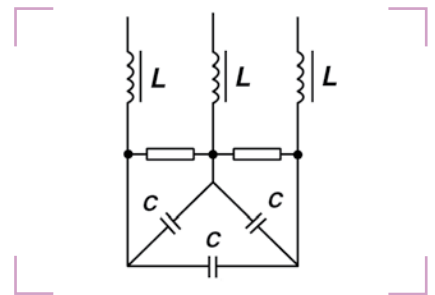

Setup of the rejection filter

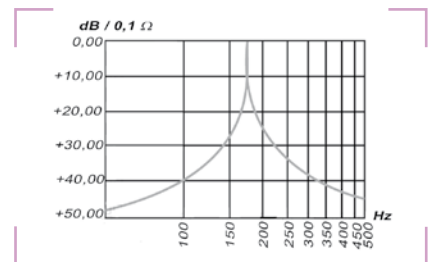

Response in standard frequencies

Direct conversion dB / 0.1 Ω to Ω			
Z	Z	Z	Z
(dB / 0.1 Ω)	Filter	(dB / 0.1 Ω)	Filter
0	0,100	20	1,00
2	0,125	22	1,25
4	0,158	24	1,58
6	0,199	26	1,99
8	0,251	28	2,51
10	0,316	30	3,16
12	0,398	32	3,98
14	0,501	34	5,01
16	0,630	36	6,30
18	0,794	38	7,94

Table 1: Conversion of dB / 0.1 Ω to Ω



Switching micro-drop filtering in the network and motor

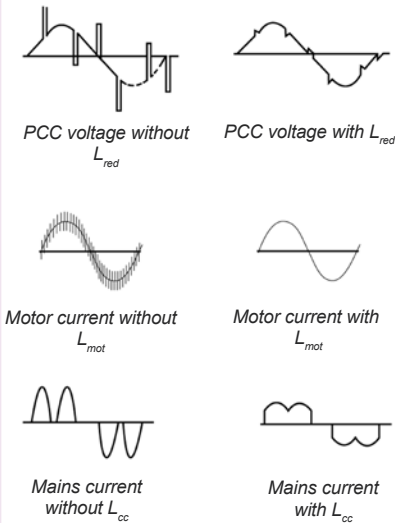
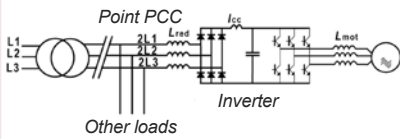

Elimination of micro-drops and filtering of harmonics

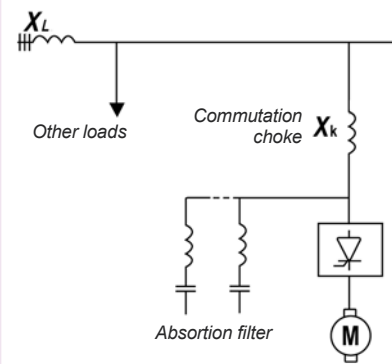

Switching improvement inductance in dc

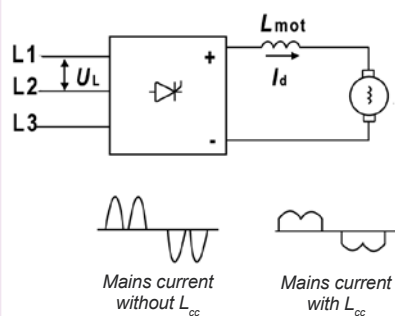

Table 1. Filter reactors

The impedances of filters are generally displayed on logarithmic charts, showing the impedances related to a standard value in order (in our case 0.1 Ω), depending on the frequency (axis of abscissas). The unit is displayed as (dB / 0.1 Ω) and defined as:

$$Z (dB / 0.1 \Omega) = 20 \cdot \log [Z (\text{filter}) / 0.1 \Omega]$$

Filter reactors for power converters

The speed regulators for direct and alternating current motors (frequency variators), UPS systems and, in general, all converters based on thyristors or power transistors, are prone to the generation of alterations in the network or an excessive rippling in the direct current side (motor, in the case of dc regulators). These alterations affect adjoining equipment and can even affect the operation of the converter.

The basic types of problems are as follows:

- Micro-drops in the voltage and excessive *di/dt* on the network side with the abovementioned equipment
- Current peaks in frequency variators, caused by the connection of capacitors to the direct current stage
- Excessive rippling and switching sparks in the motor of dc equipment

All of these problems can be solved with shock reactors or filters, as shown on table 2.

Reactors for absorption filters

These filters are composed of the branches, groups of L-C branches or harmonics being filtered. The resonance frequencies of the different groups are identical to those of the harmonics being filtered.

In construction terms, each branch is similar to that of a rejection filter, but the maximum harmonic current filtered is the important information in this case, so that the inductance and capacitor must be dimensioned for such purposes. There are many different requirements and there are no standard components

available. However, **CIRCUTOR** can design and manufacture the adequate reactors to cater for any need.

Fig. 2a and 2b show an example of the typical response of two filter branches for harmonics 5 and 7. Fig. 2c shows the response of a bank of filters composed of branches 5, 7, 11, 13 and an overlapping stage for $n > 15$.

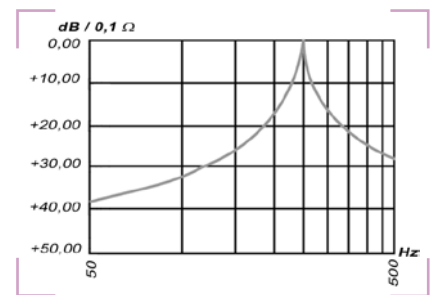

Fig.2a. Response in branch frequencies $n = 5$

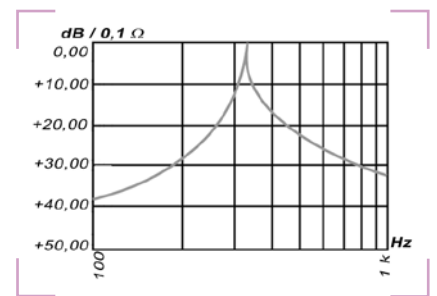

Fig.2b. Response in branch frequencies $n = 7$

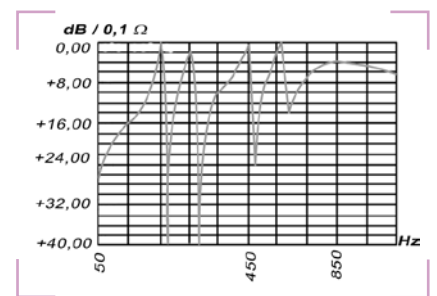

Fig.2c. Response in filter frequencies with $n = 5, 7, 11, 13, >15$

R / RX Reactors

Reactors III for harmonic rejection filters



Description

CIRCUTOR has a standard range of rejection reactors $p = 7\%$, with a resonance frequency of 189 Hz for 50 Hz networks (or on demand 227 Hz for 60 Hz networks). This is the most frequent tuning value to avoid any resonance of the 5th harmonic and above. The set of capacitors-reactors absorbs part of the current of the 5th harmonic and acts as a rejection filter for higher frequencies. In some installations, other values of $p\%$ are required, for example 5.6% (210 Hz), 6% (204 Hz), 14% (134 Hz), etc.

CIRCUTOR can build reactors on demand, which will be adapted to any power rating, $p\%$, voltage and frequency.

Low-powered reactors, **R** type, are built with plates with low losses and are coiled with a copper conductor. The connection is achieved with the adequate terminals. In the case of higher power ratings, **RB** reactors are used, with a magnetic plate nucleus and multiple steel cores, which offer excellent characteristics and a low loss ratio. Aluminum band coils are used (or copper band, on demand) and the input and output connections run through a plate.

Both **R** and **RB** type reactors have a vacuum varnish sealing to increase the insulation, providing a greater mechanical resistance and reduce the level of noise.

Features

Features	
Voltage	400 V On demand: up to 1000 V
Network frequency	50 Hz On demand: 60 Hz
Power rating	In accordance with the table Other values on demand
Value of $p\%$	7% (189 Hz) Other values on demand
Type of conductor	R : copper wire RB : aluminum band
Tolerance L	$\pm 5\%$
Linearity (5% L)	$1.8 I_n$
Isolation voltage	4 kV
Maximum room temperature	-10 °C ... +45 °C
Internal isolation	Class F (155 °C) On demand: class H (180 °C)
Maximum overload	
Permanent	$1.17 I_n$
Temporary (1 min)	$2 I_n$
Safety	
Protection thermostat	Opening at 90 °C
Degree of protection	IP 00
Indoor	Installation
Standards	
UNE-EN-60289, IEC 60076	

Application

The rejection reactors of the **R / RB** series have been specially designed for their use in capacitor banks in installations with a high harmonic content. The reactors must be connected in series to each capacitor for the adequate protection of capacitors and to avoid the resonance effects in the installation.

R / RX / RB / RBX Reactors

Reactors III for harmonic rejection filters



Dimensions

R - 7%

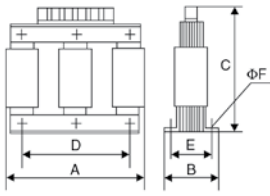

RB - 7%

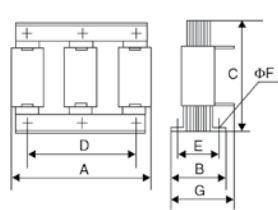

RX - 7%

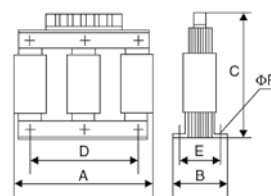

RBX - 7%

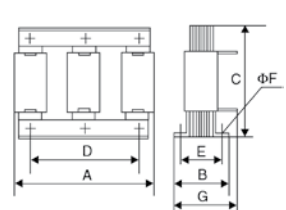

Type	a	b	c	d	e	f	g
R-5-400	155	112	165	75	85	7	--
R-10-400	180	102	190	90	75	7	--
R-15-400	180	112	190	90	85	7	--
R-20-400	260	124	174	150	90	7	150
R-25-400	260	124	174	150	90	7	150
R-30-400	290	124	231	160	90	9	150
R-40-400	293	124	231	160	90	9	150
R-50-400	310	144	233	160	110	9	175
R-60-400	305	146	260	160	110	11	180
R-80-400	335	155	280	180	120	11	185
R-100-400	338	170	300	180	135	11	215
R-120-400	355	170	350	200	135	13	220

Type	a	b	c	d	e	f	g
RX-6,25-400	180	102	190	90	75	7	--
RX-12,5-400	180	112	192	90	85	7	--
RX-20-400	180	122	190	90	95	7	--
RX-25-400	180	137	196	90	110	7	--
RBX-20-400	230	125	160				
RBX-25-400	230	125	160				
RBX-30-400	245	125	195				
RBX-40-400	250	125	195	160	110	9	175
RBX-50-400	245	145	215	160	110	9	175
RBX-60-400	263	145	235				
RBX-80-400	305	153	254				

R / RX / RB / RBX Reactors

Reactors III for harmonic rejection filters



Connections

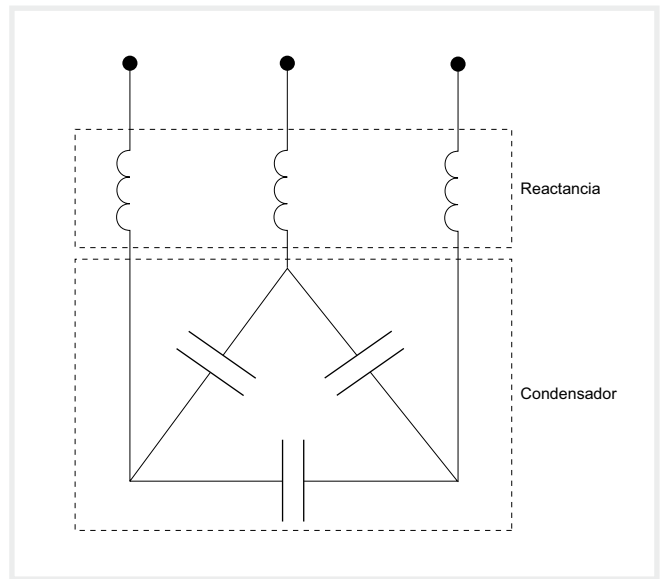

References

Reactors III series R / RB at 400 Vac, 50 Hz, $\rho = 7\%$ (189 HZ)

For capacitors:	kvar	I_n (A)	L (mH)	Losses	Weight (kg)	Type	Code
CF 46 / 6	5	7,5	7,66	25 W	6	R-5-400 / R-6-460	P70110
CF 46 / 12,5	10	15	3,83	50 W	8	R-10-400 / R-12,5-460	P70115
CF 46 / 19	15	22	2,55	57 W	9,5	R-15-400 / R-19-460	P70117
CF 46 / 25	20	30	1,92	76 W	14	RB-20-400 / RB-25-460	P70125
CF 46 / 30	25	37	1,53	90 W	14	RB-25-400 / RB-30-460	P70130
CF 46 / 37	30	45	1,27	120 W	19	RB-30-400 / RB-37-460	P70135
CF 46 / 50	40	60	0,95	145 W	20	RB-40-400 / RB-50-460	P70140
CF 46 / 62	50	75	0,76	185 W	27	RB-50-400 / RB-62-460	P70145
CF 46 / 74	60	90	0,63	205 W	31	RB-60-400 / RB-74-460	P70150
CF 46 / 100	80	120	0,47	235 W	38	RB-80-400 / RB-100-460	P70155
CF 46 / 62 x 2	100	145	0,38	250 W	50	RB-100-400 / RB-120-460	P70160
CF 46 / 74 x 2	120	175	0,32	295 W	58	RB-120-400 / RB-148-460	P70165

Reactors III series R / RB at 400 Vac, 50 Hz, $\rho = 7\%$ (189 HZ)

For capacitors:	kvar	I_n (A)	L (mH)	Losses	Weight (kg)	Type	Code
CFB 46 / 7,5	6,25	9	6,12	36	8	RX-6,25-400	P7101F
CFB 46 / 15	12,5	18	3,06	53	9,2	RX-12,5-400	P71013
CFB 46 / 25	20	30	1,92	76	11,5	RX-20-400	P71015
CFB 46 / 30	25	37	1,53	92	15	RX-25-400	P71016
CFB 46 / 25	20	30	1,92	69	12	RBX-20-400	P72125
CFB 46 / 30	25	37	1,53	106	12	RBX-25-400	P72130
CFB 46 / 37	30	45	1,27	102	16,5	RBX-30-400	P72135
CFB 46 / 50	40	60	0,95	137	17,5	RBX-40-400	P72140
CFB 46 / 62	50	75	0,76	153	21,5	RBX-50-400	P72145
CFB 46 / 74	60	90	0,63	168	24,7	RBX-60-400	P72150
CFB 46 / 100	80	120	0,47	246	33	RBX-80-400	P72155

Reactors RE / RBE

Reactors III for static capacitor banks

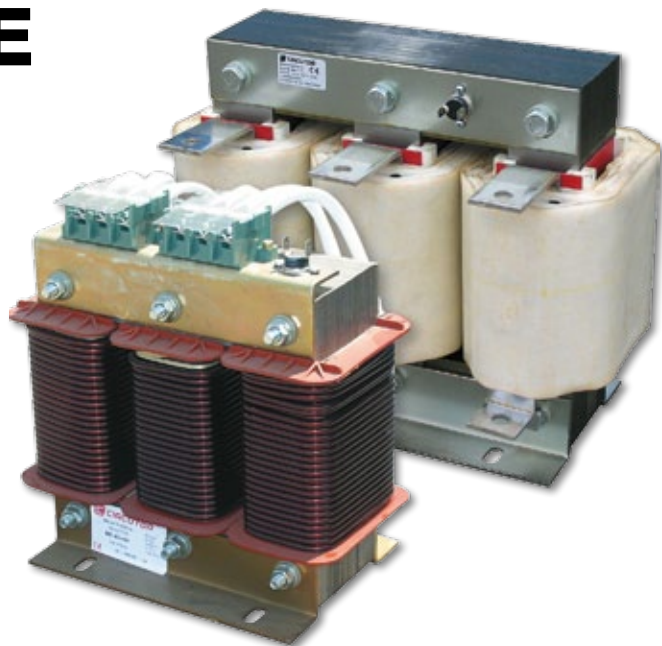

Description

CIRCUTOR has standardized the reactors of the **RE / RBE** series, with a special design for their use in static capacitor banks. The best operation of the set requires the reactors to be connected within the triangle composed by the capacitor-reactor set. At the same power rating, the **RE / RBE** reactors have a nominal current value that is 1.73 times smaller and an inductance value that is 3 times greater than that in an **R / RB** reactor.

The company has a standard range of 400 V rejection reactors with $p = 7\%$, with a resonance frequency of 189 Hz for 50 Hz networks (or on demand 227 Hz for 60 Hz networks). In addition, reactors can be manufactured on demand for static capacitor banks adapted to any value of the power rating, $p\%$, voltage and frequency.

Low-powered reactors, **RE** type, are built with plates with low losses and are coiled with copper wire. The connection is achieved with the adequate terminals. In the case of higher power ratings, **RBE** reactors are used, with a magnetic plate nucleus and multiple steel cores, which offer excellent characteristics and a low loss ratio. The coils are made with an aluminium band (or copper band, on demand). The input and output connections run through a plate.

Both **RE** and **RBE** type reactors have a vacuum varnish sealing to increase the insulation and reduce the levels of noise.

Features

Features	
Voltage	400 V On demand: up to 1000 V
Network frequency	50 Hz On demand: 60 Hz
Power rating	In accordance with the table Other values on demand
Value of $p\%$	7 % (189 Hz) Other values on demand
Type of conductor	RE : copper wire RBE : aluminum band
Tolerance L	$\pm 5\%$
Linearity (5 % L)	$1.8 I_n$
Isolation voltage	4 kV
Maximum room temperature	-10 °C ... +45 °C
Internal isolation	Class F (155 °C) On demand: class H (180 °C)
Maximum overload	
Permanent	$1.17 I_n$
Temporary (1 min)	$2 I_n$
Safety	
Protection thermostat	Opening at 90 °C
Degree of protection	IP 00
Indoor	Installation
Standards	
UNE-EN-60289, IEC 60076	

Application

The rejection reactors of the **RE / RBE** series have been specially designed for their use in capacitor banks in installations with a high harmonic content. The reactors must be connected in series to each capacitor for the

adequate protection of capacitors, the static operations module and to avoid the resonance effects in the installation.

Reactors RE / RBE

Reactors III for static capacitor banks

Dimensions

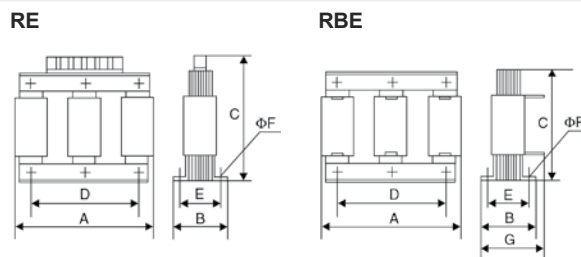

Type	a	b	c	d	e	f	g
RE-5-400	155	92	165	75	75	7	--
RE-10-400	180	102	190	90	75	7	--
RE-15-400	180	112	190	90	85	7	--
RE-20-400	180	122	190	90	95	7	--
RE-25-400	240	122	250	130	90	9	--
RE-30-400	240	132	250	130	100	9	--
RE-40-400	240	147	250	130	115	9	--
RBE-50-400	310	154	233	160	120	9	185
RBE-60-400	310	154	234	160	120	9	185
RBE-80-400	338	165	280	180	130	11	195



References

Reactors III series RE / RBE at 400 Vac, 50 Hz, $\rho = 7\%$ (189 HZ)

For capacitors:	kvar	I_n (A)	L (mH)	Losses (W)	Weight (kg)	Type	Code
CF 46 / 6-6B	5	5	23,67	25	6	RE-5-400 / RE-6-460	P70210
CF 46 / 12.50.6B	10	9	11,27	50	8	RE-10-400 / RE-12,5-460	P70215
CF 46 / 19-6B	15	13	7,50	57	9,5	RE-15-400 / RE-19-460	P70220
CF 46 / 25-6B	20	17	5,68	76	11,5	RE-20-400 / RE-25-460	P70225
CF 46 / 30-6B	25	21	4,68	90	17	RE-25-400 / RE-30-460	P70230
CF 46 / 37-6B	30	26	3,84	120	20,5	RE-30-400 / RE-37-460	P70235
CF 46 / 50-6B	40	35	2,84	145	25,5	RE-40-400 / RE-50-460	P70240
CF 46 / 62-6B	50	42	2,29	185	29	RBE-50-400 / RBE-62-460	P70245
CF 46 / 74-6B	60	51	1,89	205	30	RBE-60-400 / RBE-74-460	P70250
CF 46 / 100-6B	80	68	1,42	235	41	RBE-80-400 / RBE-100-460	P70255

Connections

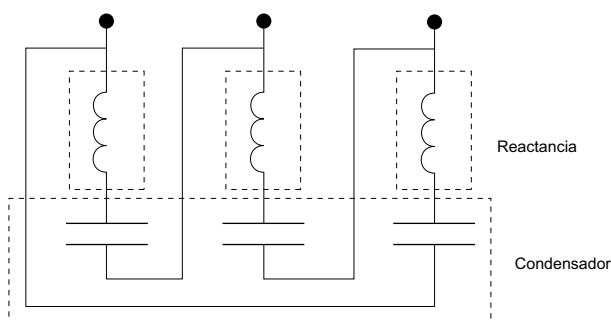

LR / LRB Reactors

Reactors for filtering for power converters
(network side)

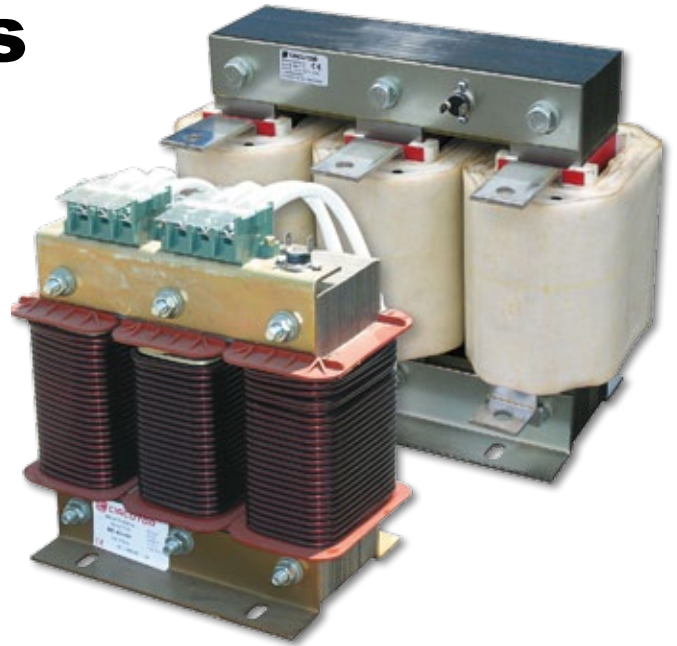

Description

The motor speed regulation equipment, frequency variators, UPS units, etc. generate alterations in the network, which affect other loads in the installation of the operation of the equipment.

The **LR / LRB** reactors connected to the input on the network side of the equipment can attenuate voltage peaks and reduce the harmonic distortion generated by the power electronics. The **LR / LRB** Reactors for filtering can reduce the current harmonics in any converter from 40... 50 % to values around 20 %. In addition, they reduce the short-circuit current and increase the safety of the converter's semi-conductors. When installed on the motor side, they can attenuate harmonic frequencies caused during switching operations.

- Low-powered reactors, **LR** type, are built with plates with low losses and are coiled with copper wire. The connection is achieved with the adequate terminals.
- In the case of higher currents, **LRB** reactors are used, with a magnetic plate nucleus and multiple steel cores, which offer excellent characteristics and a low loss ratio. Copper band coils (or aluminium band, on demand). The connections run through a plate.
- Both **LR** and **LRB** type reactors have a vacuum varnish sealing to increase the insulation, providing a greater mechanical resistance and reduce the level of noise.

Features

Features	
Voltage drop U_k % (LR 04: 400 V or Lr 02: 230 V)	4 % network at 50 Hz (4.8 % network at 60 Hz) Other values on demand
Voltage	Up to 1000 Vac
Value of L (mH)	In accordance with the table Other values on demand
Nominal current	In accordance with the table Other values on demand
Type of conductor	LR : copper wire LRB : copper band (or aluminium, on demand)
Tolerance L	± 5 %
Linearity (5 % L)	$1.5 I_n$
Isolation voltage	4 kV
Maximum room temperature	-10 °C ... +45 °C
Internal isolation	Class F (155 °C) On demand: class H (180 °C)
Maximum overload	
Permanent	$1.17 I_n$
Temporary (1 min)	$2 I_n$
Safety	
Protection thermostat	On demand
Degree of protection	IP 00
Indoor	Installation
Standards	
UNE-EN-60289, IEC 60076	

Application

The reactors of the **LR / LRB** series are prepared and can be used on the network and motor sides. They attenuate micro-drops and peaks during the initial connection and switching operations, and they reduce the rate of harmonics from the network current.

LR / LRB Reactors

Reactors for filtering for power converters
(network side)

Dimensions

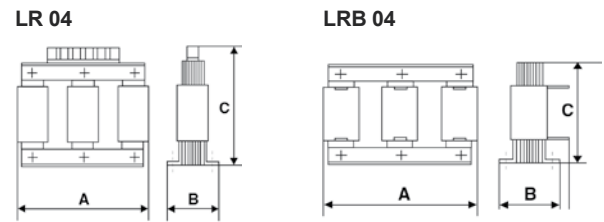

Type	a	b	c	Type	a	b	c
LR 04-003	120	60	125	LRB 04-080	180	135	160
LR 04-004	120	60	125	LRB 04-095	237	120	195
LR 04-006	120	60	125	LRB 04-115	237	131	195
LR 04-008	120	60	125	LRB 04-150	237	131	215
LR 04-010	120	70	125	LRB 04-185	242	154	256
LR 04-013	120	70	125	LRB 04-200	245	154	256
LR 04-017	150	75	150	LRB 04-250	285	154	300
LR 04-022	150	90	152	LRB 04-300	280	164	300
LR 04-033	150	90	152	LRB 04-400	320	208	350
LR 04-041	180	100	193	LRB 04-500	320	228	350
LR 04-050	180	110	197	LRB 04-600	385	320	505
LR 04-058	180	110	197				
LR 04-066	180	120	197				



References

Type of three-phase network at:	Motor power (kW)	I_n (A)	L (mH)	Losses (W)	Weight (kg)	Type	Code
380 / 415 V	0,75	2,5	14,8	6	1,8	LR 04-003	P70301
380 / 415 V	1,5	4	7,90	8	1,8	LR 04-004	P70302
380 / 415 V	2,2	5,5	5,90	10	2	LR 04-006	P70303
380 / 415 V	3	7,5	4,30	12	2	LR 04-008	P70304
380 / 415 V	4	10	3,20	15	2,3	LR 04-010	P70305
380 / 415 V	5,5	13	2,50	18	2,3	LR 04-013	P70306
380 / 415 V	7,5	17	1,85	25	3,5	LR 04-017	P70307
380 / 415 V	11	22	1,47	30	4,6	LR 04-022	P70308
380 / 415 V	15	32	0,98	45	5	LR 04-033	P70309
380 / 415 V	18,5	40	0,80	55	7,5	LR 04-041	P7030A
380 / 415 V	22	47	0,67	64	9	LR 04-050	P7030B
380 / 415 V	25	53	0,59	77	9,5	LR 04-058	P7030C
380 / 415 V	30	64	0,49	88	11	LR 04-066	P7030D
380 / 415 V	37	76	0,40	110	13	LRB 04-080	P7030E
380 / 415 V	45	90	0,34	120	18	LRB 04-095	P7030F
380 / 415 V	55	110	0,28	145	21	LRB 04-115	P7030G
380 / 415 V	75	148	0,20	190	26	LRB 04-150	P7030H
380 / 415 V	90	180	0,17	230	32	LRB 04-185	P7030J
380 / 415 V	110	200	0,15	245	36	LRB 04-200	P7030K
380 / 415 V	132	250	0,12	285	44	LRB 04-250	P7030L
380 / 415 V	160	300	0,10	355	48	LRB 04-300	P7030M
380 / 415 V	200	400	0,07	475	72	LRB 04-400	P7030N
380 / 415 V	250	500	0,06	550	80	LRB 04-500	P7030P
380 / 415 V	315	600	0,05	634	105	LRB 04-600	P7030Q

Voltage drop U_v : 4 % for 400 V - 50 Hz / 4.8 % for 400 V - 60 Hz)

LR / LRB Reactors

Reactors for filtering for power converters
(network side)



Dimensions

LR 02

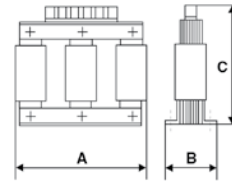

LRB 02

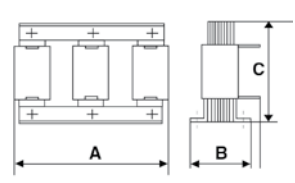

Type	a	b	c	Type	a	b	c
LR 02-004	120	60	125	LRB 02-058	180	110	197
LR 02-007	120	60	125	LRB 02-071	180	135	160
LR 02-010	120	70	125	LRB 02-083	180	135	160
LR 02-013	120	70	125	LRB 02-094	237	120	195
LR 02-016	150	75	150	LRB 02-100	237	131	195
LR 02-023	150	90	152	LRB 02-130	237	131	215
LR 02-030	150	90	152				
LR 02-039	180	100	193				

References

Type of three-phase network at:	Motor power (kW)	I_n (A)	L (mH)	Losses (W)	Weight (kg)	Type	Code
220 / 240 V	0,75	4	4,90	8	1,8	LR 02-004	P70311
220 / 240 V	1,5	7	2,60	10	2	LR 02-007	P70312
220 / 240 V	2,2	10	1,96	14	2,3	LR 02-010	P70313
220 / 240 V	3	13	1,43	17	2,3	LR 02-013	P70314
220 / 240 V	4	16	1,07	20	3,5	LR 02-016	P70315
220 / 240 V	5,5	22	0,84	26	4,6	LR 02-023	P70316
220 / 240 V	7,5	30	0,61	35	5	LR 02-030	P70317
220 / 240 V	10	38	0,49	44	7,5	LR 02-039	P70318
220 / 240 V	15	58	0,32	66	9,5	LRB 02-058	P70319
220 / 240 V	18,5	70	0,26	80	11	LRB 02-071	P7031A
220 / 240 V	22	82	0,22	94	12	LRB 02-083	P7031B
220 / 240 V	25	92	0,19	105	17	LRB 02-094	P7031C
220 / 240 V	30	112	0,16	115	20	LRB 02-100	P7031D
220 / 240 V	37	138	0,13	148	25	LRB 02-130	P7031E

Voltage drop U_k : 4 % for 230 V - 50 Hz / 4.8 % for 230 V - 60 Hz)

Connections

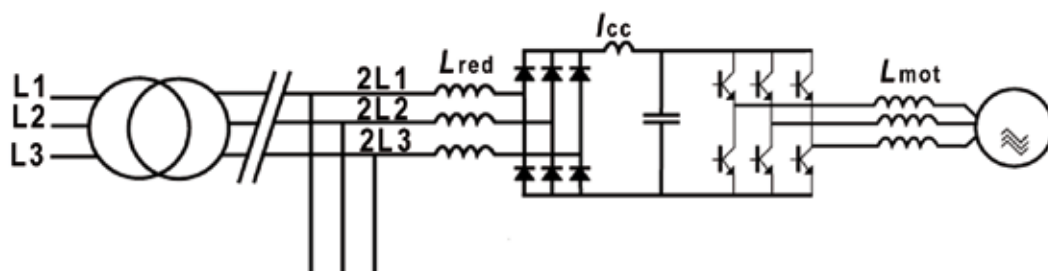



Unit 6/22 Moselle Ave, Henderson, Auckland, New Zealand
PO Box 21-872, Henderson, Auckland, New Zealand

Phone:+64 9 833 5749

Fax:+64 9 833 5726

Email: info@LPINZ.co.nz

Web: www.LPINZ.co.nz

Auckland 09 833 5749 - Wellington 04 282 0925 - Christchurch 03 281 8041 - Waikato 07 282 1011